

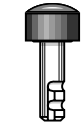

Two Piece Crisscross Bar



Lower Cam Upright Tube (A) and
Upper Telescoping Tube (B)



Helix Bolt

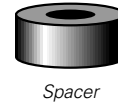

Spacer

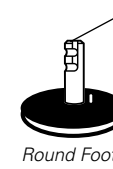

Round Foot

Helix Stud

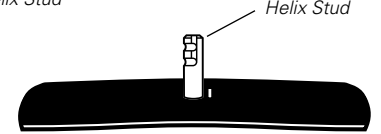

Foot

assembly instructions

1. Place four feet in an X pattern, with the round foot in the middle. Insert bottom hem of fabric/graphics through sides of crisscross bars.
2. Place first crisscross bar (with rings down, see Figure 1) over helix studs on outside feet and middle round foot.
3. Put spacers on two outside feet (with no crisscross bar currently, see Figure 2). Place second crisscross bar (with rings up) over other two outside feet (with spacers) and middle round foot.
4. Attach lower upright tubes (A) to helix studs; twist and tighten. If upper telescoping tube (B) is not in place, slide it into tube A. Note that this tube tightens in any position.
5. For ease of assembly raise upper telescoping tubes a few inches.
6. Insert top crisscross bars through top banner hems, making sure that graphics are not twisted and will line up with the crisscross bars below.
7. Place bars on top of upright tubes in same sequence as bottom bars. Place helix bolts through rings and into telescoping tube. Turn bolts to lock.
8. Check all connections (top helix bolts, bottom uprights on feet) to ensure that they are locked and tight.
9. Raise upper telescoping tubes to full height, inching each one up in order.

Figure 1

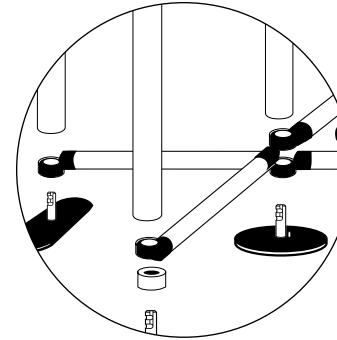
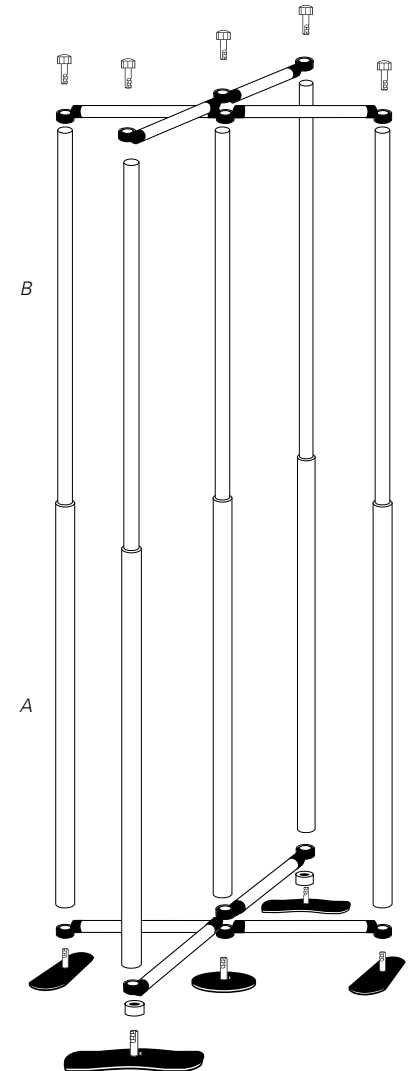
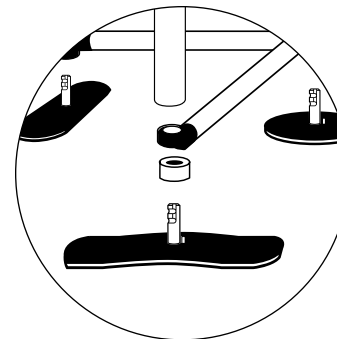

Figure 2



helpful hints

- Remove components from organizing pouch and place on pouch.
- Place paper or cloth on floor to keep fabric/graphics clean during assembly.
- Store rubber caps for feet in small pocket in organizing pouch.
- Complete assembly of all uprights before attaching top crisscross bars.
- Do not telescope tubes until unit, with fabric/graphics attached, is fully assembled.
- Check that all helix bolts and connections (intermediate and lower upright tubes, lower upright tubes and feet) are tight.